

Technical Data

KLUDI FRESHLINE
shower set 1 S
DN 15

Ref.:
6784005-00

Finishes:
05 chrome

Product description
Manufacturer KLUDI GmbH & Co. KG
Typ: KLUDI FRESHLINE
shower set 1 S DN 15
Ref.: 6784005-00

hand shower 1 S
1 spray pattern
with cleaning system
connection 1/2"
sieve seal

Shower hose
plastic coated
with metal-effect
with conical nuts
anti twist
G 1/2 x G 1/2 x 1600 mm

wall rail 900 mm
height-adjustable hand shower holder
With fixing material
for rigid wall mounting

Product picture



Dimensional drawing

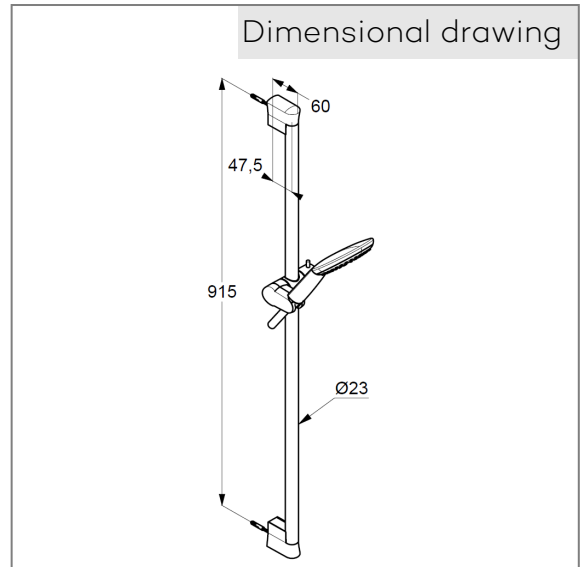

Flow rate diagram

