

Technical Data

KLUDI ZENTA
electronic controlled basin mixer
pre- installation set
190 mm

Ref.:
3850005

Finishes:
05 chrome

Product description

Manufacturer KLUDI GmbH & Co. KG

Typ: KLUDI ZENTA

Electronic controlled basin mixer

Ref.: 3850005

electronic controlled basin mixer

6V battery or 230V main adapter

trim set without pre-installation set

pre installation set KLUDI Art. Nr. 38001 and 38002

mixing shaft with temperature handle

optical object registration

Aerator, S-Pointer M24

flow rate at 3 bar = 5 l/ min.

activation optoelectrical

maximum water run- time ca. 1 minute

safety class IP65

Hygienic flushing

Product picture



Dimensional drawing

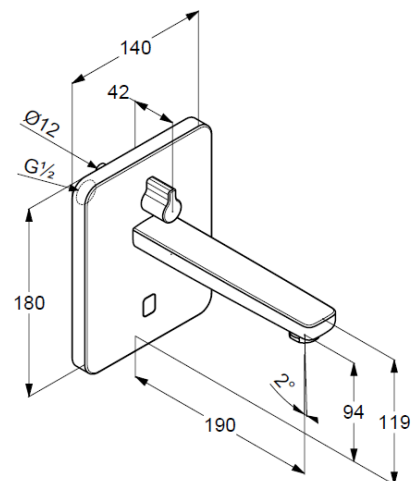

Flow rate diagram

