

Product: **KLUDI BOZZ wall mounted basin mixer DN 15**

Ref.: **381460576**

Product description

wall mounted basin mixer DN 15  
for concealed installation  
Cylindrical handles  
flow rate at 3 bar 7,8 l/min.  
PCA s-pointer aerator M 24 x l  
ceramic headparts 90°  
complete with inwall- and trim set  
spout projection 230 mm  
noise group I

Finishes:  
05 chrome

Product picture



Advertisement

wall mounted basin mixer for concealed installation, manufacturer KLUDI GmbH & Co. KG KLUDI BOZZ wall mounted basin mixer item no. 381460576, DN 15, chrome plated brass, ceramic headparts 90°, Cylindrical handles, noise level DIN EN 4109 group I, without report no., type: wall mounted basin mixer for concealed installation DN 15, flow rate at 3 bar = 7,8 l/min. PCA s-pointer aerator M 24 x l, spout projection 230 mm, complete with in-wall- and trim set, brass body 1/2 inch, for pressure type water heater, continuous line heater, PN 10,

Dimensional drawing

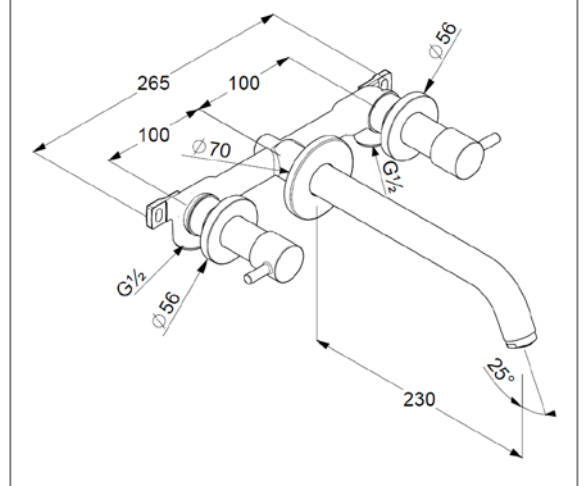

Flow rate diagram

